

32mm + 5mm (screw cap)

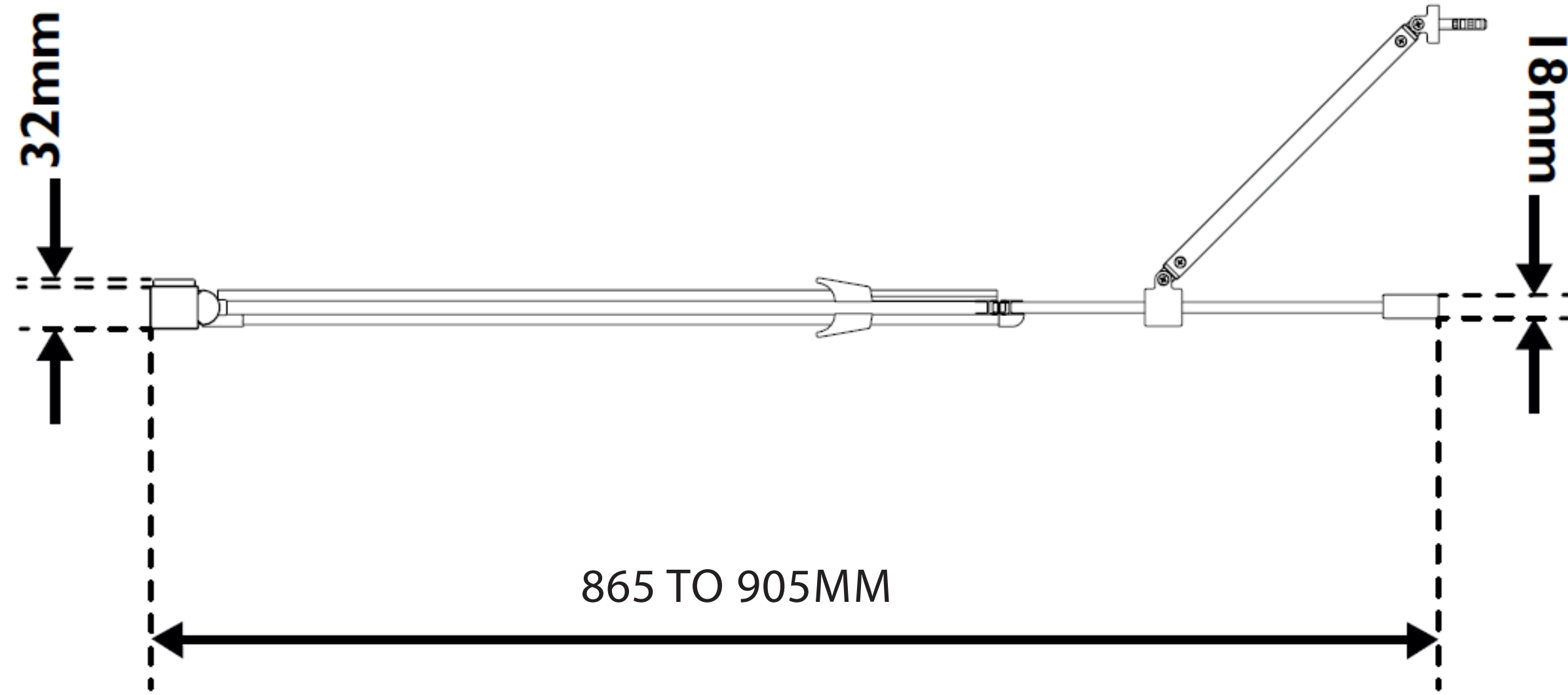

865 TO 905MM

18mm

ENCLOSURE HEIGHT = 2000MM